

RAIDON
Your Data Security Guardian

InTANK
iR2024S
User Manual

» InTANK iR2024S User Manual	1
1. Package Contents and Product Views	1
2. Operation Information.....	2
3. Hardware Requirements and Precautions	3
4. Hardware Installation Procedure	3
5. Computer Setup	5
6. Hard Disk Status on LCD Screen.....	6
7. Description of Front Panel Operation	6
8. Data Rebuilding Operation	7
9. GUI Monitoring Software and Firmware Update	8
10. Questions & Answers	10
» InTANK iR2024S 產品使用說明	12
1. 產品外觀及包裝內容	12
2. 環境需求	13
3. 硬體需求與注意事項	13
4. 硬體安裝	14
5. 電腦設定	15
6. 訊息顯示	16
7. 前面板操作	16
8. 資料重建功能說明.....	17
9. GUI 功能說明與韌體更新	18
10. 常見問題	21

Introduction

Thank you for purchasing RAIDON products. This User Manual will introduce you the InTANK iR2024S storage product. Before using your iR2024S, please read it thoroughly. Although all information contained in this User Manual had already been carefully verified before publishing, however, the actual product and its specification will be based upon the time of delivery from RAIDON. Any update to the product or its relevant information may be listed on www.raidon.com.tw. Product is subjected to change without prior notifications.

If you have any question regarding to the product you purchased, or you would like to know the latest product information, User Manual's update, please contact to your local supplier or visit to www.raidon.com.tw for further information.

Copyright © Raidon Technology, Inc. – All right is reserved.

1. Package Contents and Product Views

Open the package and you should find the following parts:

iR2024S
iR2024S x1 (with removable drive tray enclosed x2)
SATA Cable x1
Quick Installation Guide x1
Screws & Keys

- Please check the product and accessories for any defect or missing parts. If you have any questions, please contact your product supplier.
- Please visit the official website (www.raidon.com.tw) to download drivers and other related resources.

Product View, Front and Back

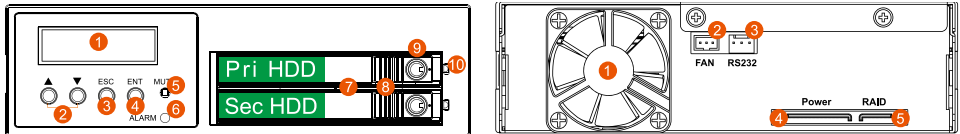

- | | | |
|--------------------|----------------------------|--------------------------------|
| 1. LCD Display | 6. Power Failure Indicator | 1. Cooling Fan |
| 2. UP/DOWN Buttons | 7. HDD Tray Handle | 2. Fan Connector |
| 3. ESC Button | 8. HDD Tray Ejection | 3. RS232 Port |
| 4. Enter Button | 9. HDD tray key lock | 4. SATA 15-pin Power Connector |
| 5. Mute Button | 10. HDD Access Indicator | 5. SATA 7-pin Connector |

LED Indicators :

Status	Power / Failure Indicator	HDD Access Indicator		Buzzer
		TRAY 1	TRAY 2	
No HDD	Purple light always on	Red light always on		ON
HDD Idle	Blue light always on	Blue light always on	Red light always on	N/A
Access	Blue light always on	Purple light lashing	Red light always on	N/A
HDD 1 Failure	Purple light always on	Red light always on		ON
HDD 2 Failure	Purple light always on	Blue light always on	Red light always on	ON
Backup	Blue light always on	Blue light always on	Red light flashing	N/A
Fan Failure	Purple light always on	Blue light always on	Red light always on	ON
Overheat ($\geq 50^{\circ}\text{C}$)	Purple light always on	Blue light always on	Red light always on	ON

2. Operation Information

Operating Temperature : 5 ~ 35 °C (41 ~ 95 °F)

Storage Temperature : -10 ~ 70 °C (14 ~ 158 °F)

Line Voltage : 5V DC

3. Hardware Requirements and Precautions

1. Computers or servers must be with SATA I, SATA II, or SATA III.
2. Hard drive must be with SATA I, SATA II, or SATA III.
3. Once the drive mode configuration has been completed, re-configuration using the same hard drives to set the drive mode will result in complete data loss. If you must change the drive mode, make sure to backup all data prior to the mode change.
4. All existing data will be deleted when this product is set up for the first time. Please ensure that all data on the hard disk has been backed up before installation to avoid data loss.
5. Please make sure that the two hard drives are free from bad blocks or defects prior to installation in order to avoid system crashes or data loss.
6. The usable storage capacity of the hard disk after formatting will be less than the capacity indicated on the hard disk.
7. It is highly recommended for user to back up important data contained within the iR2024S unit on a regular basis or whenever the user feels necessary to a remote or a separate storage device. RAIDON will not be responsible for any lost of data caused during the use of the unit or the recovery of the data lost.

4. Hardware Installation Procedure

Please follow the instructions below to complete the hardware installation.

Step 1 After unlocking the HDD tray key lock with the key attached to the accessory, push the HDD tray ejection to the right and the removable drive tray will pop open to remove the removable tray.

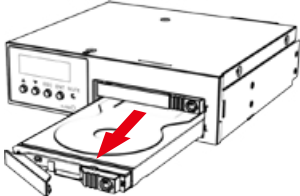
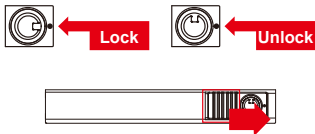

Step 2 Install the 2.5-inch hard disk and secure it with the small screws included in the 4 parts package.

Step 3 When the hard drive installation has been completed, insert the hard drive tray into the system horizontally and secure the latch into place.

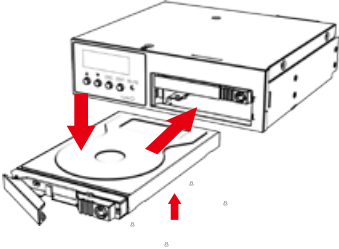

Step 4 Install device into one of the CD-ROM bays with screws from the accessory kit. Then properly connect SATA cable and SATA power cable from your system to the device.

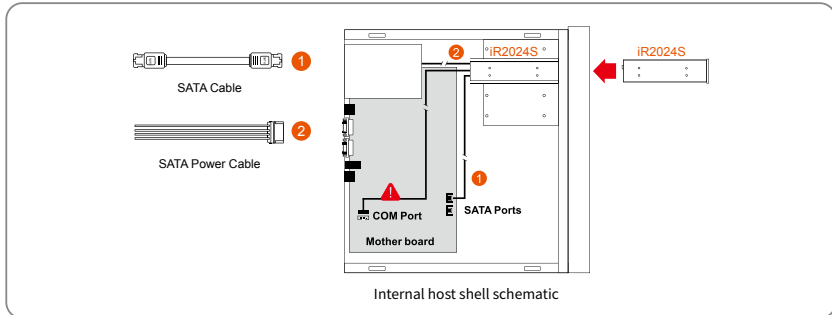

※ Note :

1. RS232 Port and RS232 Cable: Provides hardware status monitoring to industrial control system or IPC via RS232.
2. We do not recommend users to disassemble the device without proper instructions and authorization. The manufacture warranty will not cover the damages caused by unauthorized disassembling.
3. To prevent the device from malfunction, please make sure the device is connected with a direct and dedicated power connection of a stable power input.
4. RS232 Port: For industrial control system or IPC to monitor the hardware status. More information, please contact your sales window or supporting@raidon.com.tw

Step 5 Power on your system after hardware installation is completed, and your operating system will automatically detect the hard drives from booting. Then follow the steps from your operating system to partition and format the drives when necessary, device will be ready to use once the format is completed.

5. Computer Setup

When the hardware setup for iR2024S is complete, you are now ready to turn the machine on.

After the hardware installation is complete, the iR2024S will be treated as one single hard drive. When the computer is turned on, the system will retrieve the following information.

1. Device Manager Utility of Window OS will automatically detect the hard drive(s).
2. You can choose to format the hard drive by using the Disk Management tool of the operating system before using the iR2024S.

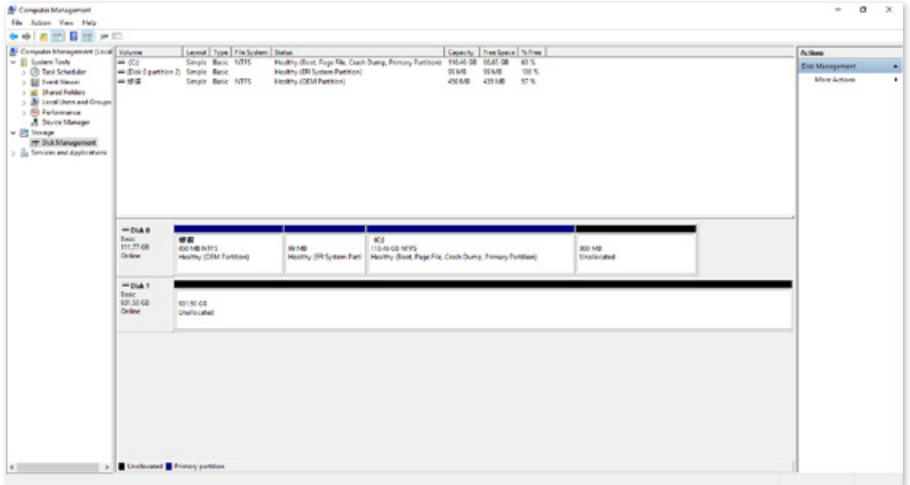

At this point, the installation process is completely finished. The user can freely retrieve and save data to iR2024S just like retrieving and saving data to a regular hard drive. If the user has any problem during the operation, please refer to the Question & Answer (Q&A) section in Appendix.

6. Hard Disk Status on LCD Screen

1. Booting and Normal status

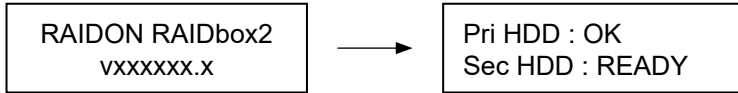

2. Fan Failure

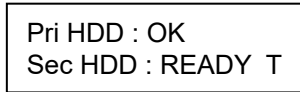

3. Over Temperature ($\geq 50^{\circ}\text{C}$)

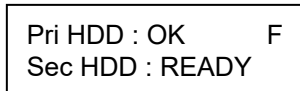

4. HDD1 is corrupted while HDD2 still exists

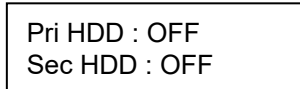

5. HDD2 is corrupted or not installed while HDD1 is still accessible

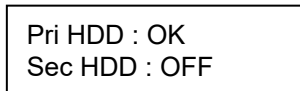

7. Description of Front Panel Operation

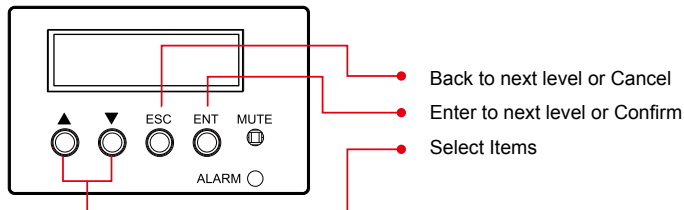

8. Data Rebuilding Operation

With hard disk hot-swappable and scheduled backup functions.

Offline backup. After the data is stored in the iR2024S, the user uses the secondary hard disk (HDD 2) as a data backup disk to ensure the security of related data such as operating system files, encrypted files, less accessed files, and even audio and video files. Users can put the hard disks back to the iR2024S periodically to perform automatic data reconstruction to ensure that the system will not be attacked by viruses or reduce the risk of simultaneous damage to two hard disks.

When one of the hard disks in the iR2024S is damaged, the system will send an alert through the LCD screen and monitoring software. Users can take out the damaged hard disk without turning off the machine while the system is still running.

When the iR2024S detects a hard drive missing or a hard drive failure, the Buzzer will start and the LCD display screen will display the following messages:

Pri HDD : OFF
Sec HDD : OFF

Pri HDD : OK
Sec HDD : OFF

After removing the failed hard drive and replacing with a new hard drive, if the hard drive is properly installed, the LCD display screen will display the following messages:

Pri HDD : OK
Sec HDD : Insert

Pri HDD :Insert
Sec HDD : OK

When entering the scheduled backup time, the LCD screen will show the progress of data backup:

Backup
Pri → Sec 32%

When the data backup is complete, the LCD screen will display the following message:

Pri HDD : OK
Sec HDD : READY

9. GUI Monitoring Software and Firmware Update

Users can download the GUI software from the [website](#) to monitor the status of the product.

1. System Status:

This GUI automatically detects your iR2024S and reveals relative information accordingly.

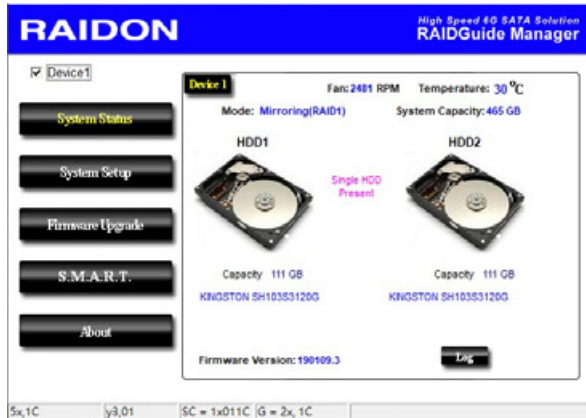

2. Schedule Backup

You can schedule backups through this GUI. Click the backup cycle and click "Setting" to complete the setting.

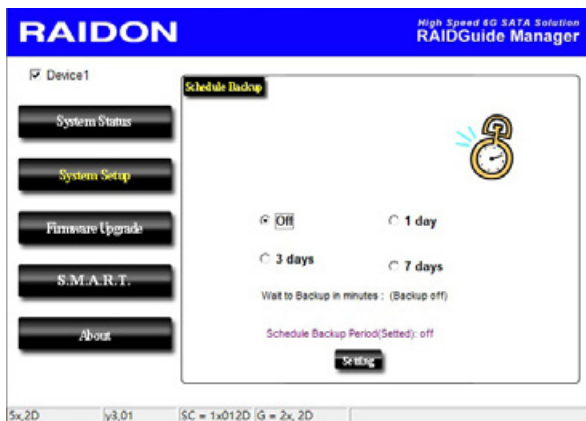

3. Firmware Upgrade

You may update the Firmware via this GUI, simply click on “Load” button to locate the firmware file to proceed. After update is finished, you may restart the power properly to operate with newly updated firmware.

4. S.M.A.R.T.

Provides information on the hard drive S.M.A.R.T installed in the disk array device.

ID	Value	Worst	Threshold	RAW	Status
01-Raw read error rate	200	200	51	000000000000	Good
02-Spinup time	101	171	21	00000000073E	Good
04-Start/Stop count	78	78	0	00000000574C	Good
05-Reallocated sector count	200	200	140	000000000000	Good
07-S seek error rate	200	200	0	000000000000	Good
09-Power-on hours count	93	93	0	000000000462	Good
0A-Spinup retry count	100	100	0	000000000000	Good
0B-Calibration retry count	100	100	0	000000000000	Good
0C-Power cycle count	100	100	0	0000000002D9	Good
0D-Power-off retract count	200	200	0	000000000285	Good
0E-Load/Unload cycle count	193	193	0	000000000585	Good
C2-Temperature	112	81	0	00000000001F	Good
C4-Reallocation Event count	200	200	0	000000000000	Good
C5-Current pending sector count	200	200	0	000000000000	Good

At the bottom, it shows '5x,49 | y3,01 | SC = 1x0149 | G = 2x, 49'.

5. About Indicates GUI Management Software version

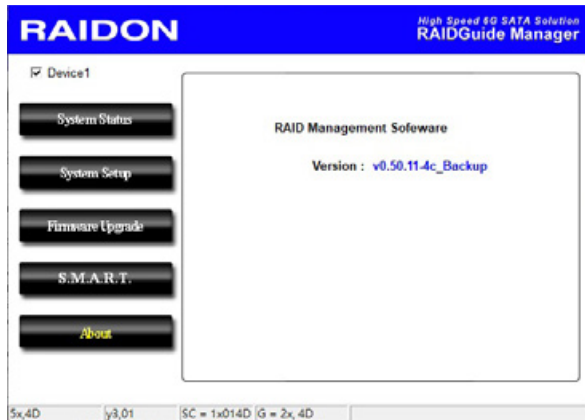

10. Questions & Answers

Unstable system after connecting iR2024S

Q1. After installing iR2024S, we are unable to start the computer or the computer can not locate iR2024S upon startup.

- A:
1. Please check whether the readings on the iR2024S LCD display screen appear normal.
 2. Please check whether the SATA Cable connection cables are properly connected to the computer system and whether SATA drives are functioning normally.
 3. If everything is functioning properly but the user still can not start the computer system, then the problem might be the system incompatibility. If such incompatibility takes place, please contact our technical support department.

Q2. When the iR2024S is in use, the computer system is functioning normally but the iR2024S access speed is abnormal.

- A:
1. Please examine if the length of the connection cables, SATA cable that connect the drives to the computer system is too long and whether the specification these cables complies with the requirements.
 2. If both the lengths and specification of the cables are checked out ok, please turn off iR2024S and remove the hard drive from iR2024S. Test the hard drive directly with the computer system since it might be the bad sectors in the hard drive that are causing the longer than normal system down time.

Hard Drive Failure

Q1. What will be the system's total storage capacity when adding a brand new hard drive?

- A:
1. The total storage capacity for iR2024S is determined by the storage capacity of the primary hard drive installed during the initial usage.
 2. The storage capacity will not increase after initial installation even when place a brand new hard drive with larger storage capacity.

Why does the error message appear when I installed the second hard drive?

Q2. The storage capacity of the second hard drive must be larger than the first hard drive.

A: Otherwise, iR2024S can not rebuild the new hard drive.

About Auto Rebuilding Function

Q1. What will happen if we turn off the computer's power while iR2024S is still executing data auto rebuilding?

A: If the power is out of the auto rebuilding process, the controller will remember when completion percentage of the auto rebuilding process and resume the rebuilding process when the power is back on.

Q2. Is it possible to lose any part of the data during the data auto rebuilding?

A: The data auto rebuilding function will copy data from one sector to another sector. Technically speaking, the data will not be lost during the auto rebuilding process. However, if the original hard drive is detected with bad sectors during the rebuilding process, iR2024S will make hypothetical duplication instead of treat the bad sectors as hard drive failure. Therefore, the data stored in the bad sectors could potentially be lost during rebuilding.

關於這份手冊

感謝您使用 RAIDON 的產品。本手冊將介紹 InTANK iR2024S 產品。在您開始使用 iR2024S 系列產品前，建議您先閱讀過本手冊。手冊裡的資訊在出版前雖已被詳細確認，實際產品規格仍將以出貨時為準；任何產品規格或相關資訊更新請您直接到 www.raidon.com.tw 網站查詢，本公司將不另行通知。若您想獲得 RAIDON 最新產品訊息、使用手冊、韌體或對 RAIDON 產品有任何疑問，請您聯絡當地供應商或到 www.raidon.com.tw 取得相關訊息。

本手冊相關產品內容歸銳銳科技股份有限公司版權所有

1. 產品外觀及包裝內容

打開包裝外盒後，包裝內容應包含下列組件：

iR2024S
iR2024S 產品本體 x1(內含抽取盒 x2)
SATA 線 x1
快速安裝導引 x1
螺絲及鑰匙

- 請確認相關配件與產品本身是否有受損或配件缺少，若有任何疑問請與本產品供應商聯絡。
- 請前往官網 (www.raidon.com.tw) 下載驅動程式以及其餘相關資源。

正面與背面示意圖

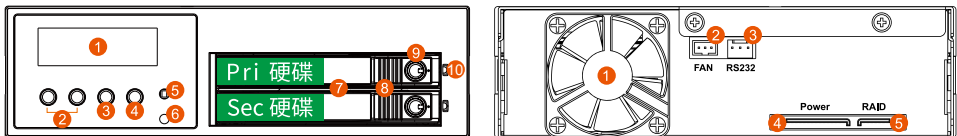

- | | | |
|------------------|---------------|---------------------|
| 1. 液晶顯示面板 | 6. 電源 / 故障顯示燈 | 1. 風扇 |
| 2. 選擇鍵 (UP/DOWN) | 7. 硬碟抽取盒把手 | 2. 風扇連接埠 |
| 3. 取消鍵 (ESC) | 8. 頂出按鍵 | 3. R232 連接埠 |
| 4. 確認鍵 (Enter) | 9. 硬碟抽取盒鎖 | 4. SATA 15Pin 電源輸入埠 |
| 5. 靜音按鈕 (MUTE) | 10. 硬碟讀寫燈 | 5. SATA 7Pin 資料連接埠 |

燈號一覽表：

狀態	電源 / 故障顯示燈	硬碟讀寫燈		蜂鳴器
		TRAY 1	TRAY 2	
無硬碟	紫燈恆亮	紅燈恆亮		鳴叫
待機	藍燈恆亮	藍燈恆亮	紅燈恆亮	N/A
資料存取	藍燈恆亮	紫燈閃爍	紅燈恆亮	N/A
HDD 1 故障	紫燈恆亮	紅燈恆亮		鳴叫
HDD 2 故障	紫燈恆亮	藍燈恆亮	紅燈恆亮	鳴叫
備份	藍燈恆亮	藍燈恆亮	紅燈閃爍	N/A
風扇故障	紫燈恆亮	藍燈恆亮	紅燈恆亮	鳴叫
溫度過高 ($\geq 50^{\circ}\text{C}$)	紫燈恆亮	藍燈恆亮	紅燈恆亮	鳴叫

2. 環境需求

工作溫度：0 ~ 40 °C (32 ~ 104 °F)

儲存溫度：-10 ~ 70 °C (14 ~ 158 °F)

工作電壓：5V DC

3. 硬體需求與注意事項

1. 電腦或伺服器具備 SATA I、SATA II 或 SATA III 介面。
2. 具備 SATA I、SATA II 或 SATA III 介面的硬碟。
3. 本系統允許使用不同廠牌的硬碟。但如果要獲得更好的效能，我們強烈建議使用相同廠牌型號的硬碟。
4. 第一次使用本產品進行設定時，資料會被全數清除。請於硬碟置入前，確認硬碟已備份，避免資料遺失。
5. 安裝硬碟前請先確認所使用的硬碟並無壞軌或是其他問題，以免導致系統損毀或資料遺失。
6. 硬碟格式化後的可使用儲存容量會小於硬碟標示的容量。
7. 強烈建議除了使用 iR2024S 系列的資料儲存功能外，請針對重要資料備份到另一個儲存裝置上或遠端備份，雙重備援您重要的資料。若您儲存在 iR2024S 系列的資料損毀或遺失，RAIDON 將不負任何的責任。

4. 硬體安裝

請參照以下步驟完成硬體安裝

步驟 1 請使用零件包內附的鑰匙解鎖硬碟抽取盒鎖，將頂出按鍵向右推移，硬碟抽取盒把手便會彈開，即可取出抽取盒。

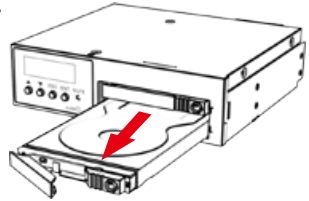
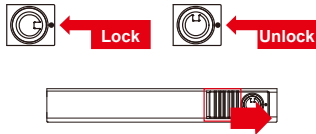

步驟 2 安裝 2.5 吋硬碟，請使用 4 顆零件包內附的小顆螺絲加以固定。

步驟 3 硬碟安裝完成後請將抽取盒平移放入主機內並關上把手。

步驟 4 將主體安裝於電腦機殼上的 CD-ROM 位置，並使用配件包裡的螺絲固定，並連接 SATA 連接線與 SATA 電源線。

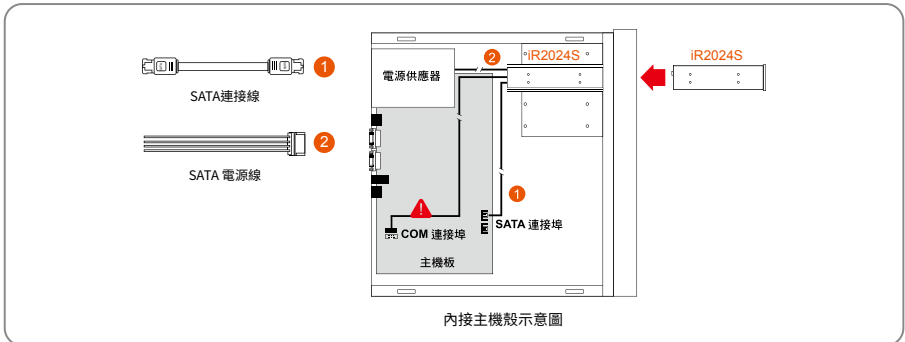
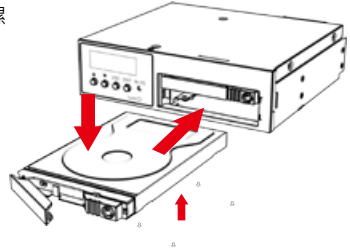

※ Note :

1. RS232 埠與 RS232 線：提供工控系統或是工業電腦透過 RS232 監控硬碟狀態。
2. 我們不建議使用者在未經授權的情況下自行拆卸系統。如未經授權自行拆卸所導致的損毀將不在保固之列。
3. 為了防止系統發生問題，請確保系統的電源供應是穩定且獨立的。
4. RS232 連接埠和 RS232 連接線：提供工控產業或 IPC 產業透過 RS232 進行硬體狀態偵測，如有需要可向銳鈞銷售 / 客服人員 supporting@raidon.com.tw 索取相關資料。

步驟 5 硬體安裝完成。一旦開啟電腦，您的作業系統會自動辨識所裝置好的硬碟。如果您的硬碟是必須被格式化的，請依照電腦的作業系統進行硬碟格式化步驟。當完成硬碟格式化後，硬碟便可以進行資料讀寫。

5. 電腦設定

當 iR2024S 的硬體安裝完成，即可準備進行開機動作。

硬體安裝完成後，將 BIOS 的硬碟偵測設定為自動，iR2024S 將會被視為如同一顆硬碟一般。當電腦開機後，系統會顯示下列偵測訊息：

1. 安裝在 iR2024S 中的硬碟能夠被 Windows 的裝置管理員偵測到。
2. 使用 iR2024S 前，使用者可以透過磁碟管理選擇硬碟的格式。

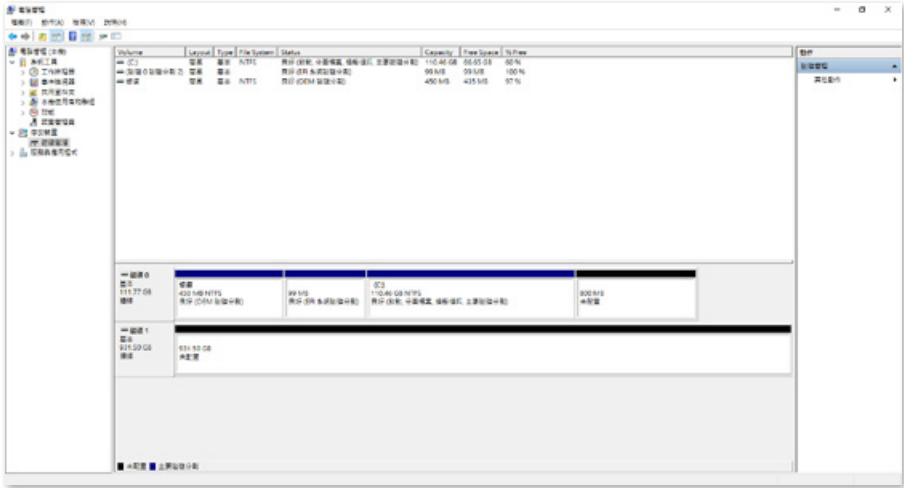

到此完成整個安裝程序。使用者可以如同存取一般硬碟般的使用 iR2024S。如果使用上仍有問題，請參閱附件的 Q&A。

6. 訊息顯示

1. 開機與正常待機狀態



2. 溫度過高 ($\geq 50^{\circ}\text{C}$)

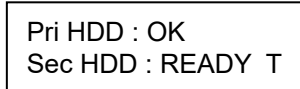

3. 風扇故障

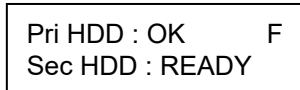

4. HDD1 損毀而 HDD2 仍然正常存在

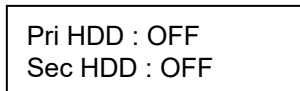

5. HDD2 損毀或未安裝而 HDD1 仍然可正常存取

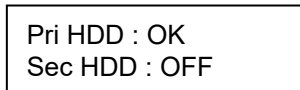

7. 前面板操作

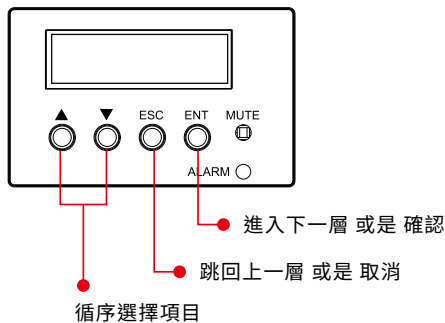

8. 資料重建功能說明

具備硬碟熱抽拔與自動資料重建功能。

離線備份。當資料儲存在 iR2024S 後，使用者可以移除其中一顆硬碟當作資料備份碟，確保相關資料例如作業系統檔案、加密文件、較少存取的檔案甚至影音檔案的安全。使用者可以定期的將硬碟放回 iR2024S 執行自動資料重建，確保系統不會被病毒攻擊或是減少兩顆硬碟同時損毀的風險。

當 iR2024S 中的其中一顆硬碟損毀，系統會透過 LCD 顯示幕與監控軟體發出警示。使用者可以在系統仍在運作下，無需關掉機器即可將損毀的硬碟取出。一但替換損毀硬碟後，iR2024S 即會在不影響系統運作的情況下自動開始進行資料重建，使用者也無需對 iR2024S 下任何指令。

當 iR2024S 偵測到硬碟遺失或是損毀，蜂鳴器會啟動，LCD 螢幕會顯示以下訊息：

Pri HDD : OFF
Sec HDD : OFF

Pri HDD : OK
Sec HDD : OFF

當移除損毀的硬碟並替換一顆新硬碟後，如果新硬碟有正確安裝，LCD 螢幕會顯示以下訊息：

Pri HDD : OK
Sec HDD : Insert

Pri HDD : Insert
Sec HDD : OK

安裝新硬碟後幾秒鐘，LCD 螢幕會顯示資料重建的進度：

Backup
Pri → Sec 32%

當資料重建完成後，LCD 螢幕會顯示以下訊息：

Pri HDD : OK
Sec HDD : READY

9. GUI 功能說明與韌體更新

使用者可以從網站下載來安裝 GUI 軟體，藉此監控產品的狀態。

1. 系統狀態

GUI 會自動偵測 iR2024S 並且顯示相關資訊

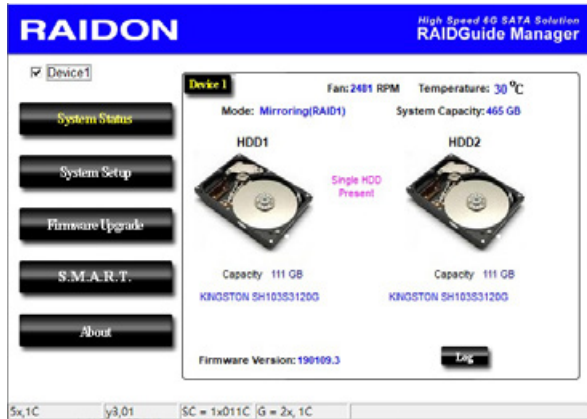

2. 排程備份

使用者可以透過此 GUI 進行排程備份。點選備份的週期再點選 "Setting" 即可完成設定。

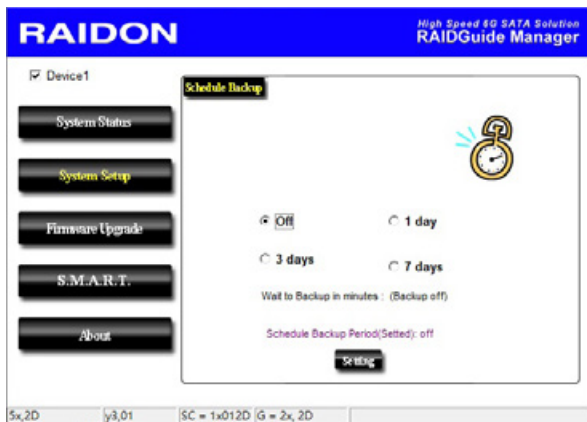

3. 韌體升級

使用者可以透過此 GUI 進行韌體升級。只需簡單的點選 "Load" 指定韌體檔案位置後再點選 "Upgrade" 即可進行升級。升級過程或許需要重新啟動系統來完成整個升級程序。

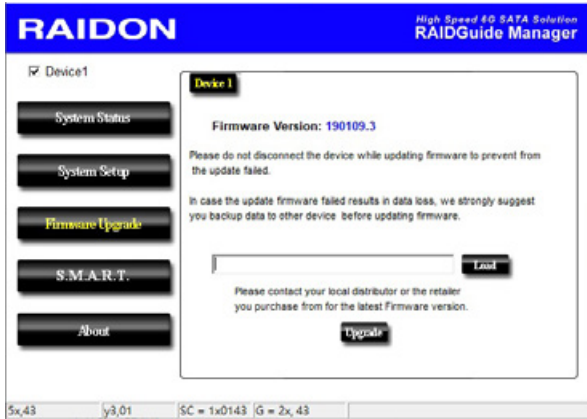

※ 注意：任意更新韌體有可能導致系統運作不正常。強烈建議如果系統運作正常情況下不要進行韌體升級。

4. S.M.A.R.T.

提供磁碟陣列設備中所安裝硬碟 S.M.A.R.T 資訊。

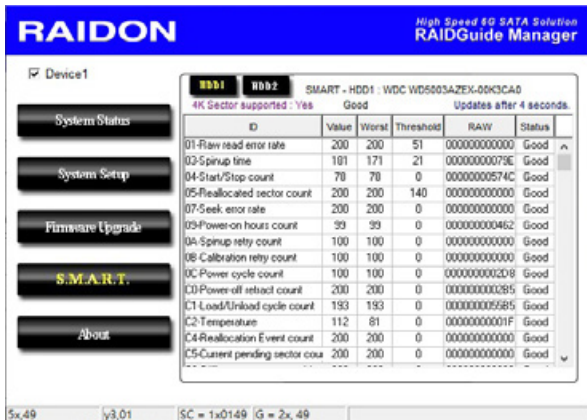

4. 關於 GUI 軟體版本

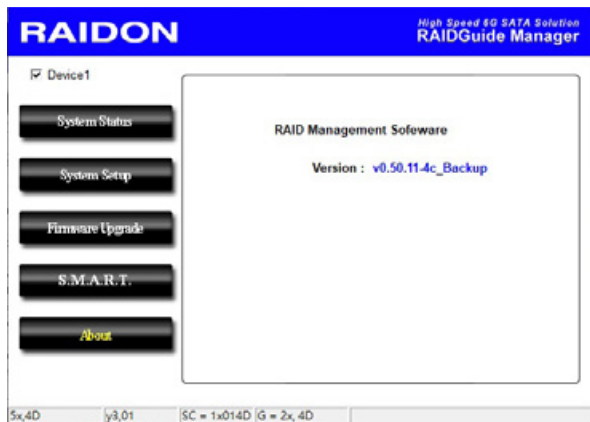

10. 常見問題

連接 iR2024S 後系統不穩定

Q1. 安裝完 iR2024S 後，電腦無法開機或是電腦認不到 iR2024S。

- A:
1. 請確認 iR2024S 上的 LCD 螢幕顯示正常。
 2. 請確認 SATA 線有正確的跟電腦連接且硬碟是可正常運作。
 3. 如果一切正常但使用者還是無法正常開機，這有可能是因為硬體上的相容性問題。如果是硬體上相容性問題，請聯繫我們的客服部門。

Q2. 使用時，電腦運作正常但是 iR2024S 的存取效能不正常。

- A:
1. 請確認 iR2024S 是否正在資料重建。
 1. 請確認所使用的連接線長度，是否所使用的 SATA 線太長以及是否合乎標準規範。
 2. 如果線材的長度與規格都沒問題，請關閉 iR2024S 並取出其中的硬碟。直接接硬碟連接到電腦並進行檢測，有可能是硬碟中的壞軌導致。

硬碟損毀

Q1. 如果放入一顆新的硬碟，系統的總容量會是？

- A:
1. iR2024S 的總容量是依據一開始安裝的主硬碟容量而定。
 2. 安裝完成後，即使更換一顆較大容量的硬碟，儲存容量也不會增加。

Q2. 為何當我安裝第二顆硬碟時出現錯誤訊息？

- A: 第二顆硬碟的容量必須大於第一顆硬碟，否則 iR2024S 不會進行資料重建。

關於資料自動重建功能

Q1. 如果當 iR2024S 在資料重建時關掉電腦電源，會不會怎樣？

- A: 資料重建過程中關閉電源，控制器會自動記憶已完成的百分比，當再度開啟電源後，重建過程會從斷電前的百分比繼續。

Q2. 資料重建過程中是否有可能會遺失資料？

- A: 資料重建功能是 Sector to Sector 的拷貝方式。技術上來說，資料並不會在資料重建過程中遺失。但是，如果資料重建過程中，原本的硬碟 (Source) 被偵測到壞軌，iR2024S 將會採用模擬方式而不會因此壞軌認為硬碟損毀。因此，這種情況下儲存在壞軌的資料就有可能會遺失。

RAIDON
Your Data Security Guardian
www.raidon.com.tw